

MAINTENANCE

Empty dust cup after each use

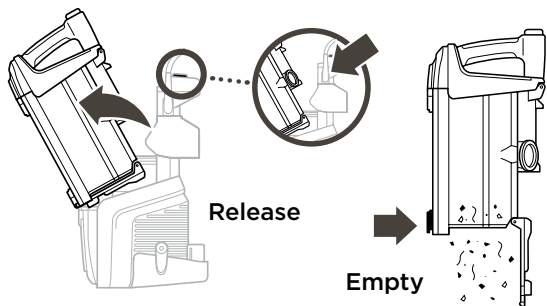

Filter Maintenance

Wash filters regularly to keep the suction strong.

Rinse filters with water only, and allow them to air-dry completely before reinstalling. Tap loose dirt from foam filters as needed between washes.

See enclosed Owner's Guide for complete details on removing and cleaning filters.

Self-cleaning brushroll

The self-cleaning brushroll delivers nonstop hair removal while you vacuum, sending it to the dust cup. To clear any blockages, see instructions below.

NOTE: If you see any hair wrapped around the brushroll, continue cleaning, using CARPET/LOW PILE mode on a bare floor surface.

Clearing Blockages

1. To open the brushroll garage, slide both release buttons on the floor nozzle away from you, toward the back of the nozzle, then lift off the lid.
2. Clear away any objects or debris.
3. To close the brushroll garage, insert the 3 tabs on top of lid into the 3 slots in the nozzle, then push down on both sides of lid until it clicks securely into place. If the Brushroll Indicator Light isn't green and headlights are flashing, check again that both sides of lid are locked in place.

Brushroll Maintenance

Carefully remove any debris that may be impeding the brushroll.

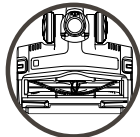

Cleaning the Soft Roller

Lift out the Soft Roller by pulling the tab on the right side. Clear away any debris, then slide the Soft Roller back into place.

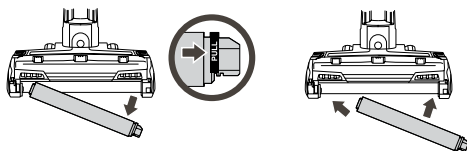

Checking the Nozzle for Blockages

Tilt neck of nozzle back to straighten the airway, then remove any blockages.

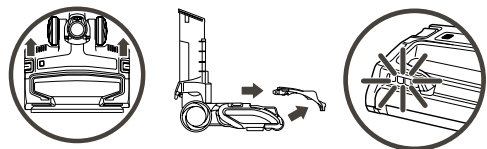
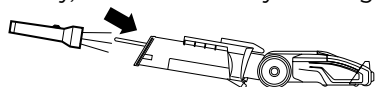

Please be sure to read the enclosed Shark® Owner's Guide prior to using your vacuum.

duo clean Self-cleaning brushroll

Shark APEX™

POWERED LIFT-AWAY®

QUICK START GUIDE

Use this Quick Start Guide to start using your new vacuum's great features.

Register your vacuum at registryyourshark.com

For additional parts and accessories, visit sharkaccessories.com



For questions or to register your product, visit us online at sharkclean.com

©2019 SharkNinja Operating LLC. DUOCLEAN, LIFT-AWAY, POWERED LIFT-AWAY, and SHARK are registered trademarks of SharkNinja Operating LLC. APEX is a trademark of SharkNinja Operating LLC.

AZ1002C_QSG_MP_Mv2



AZ1002C

WHAT'S INSIDE:

- A Handle
- B Hose
- C Vacuum Pod
- D Wand
- E Motorized Floor Nozzle
- F Upholstery Tool
- G Pet Power Brush
- H 12" Crevice Tool

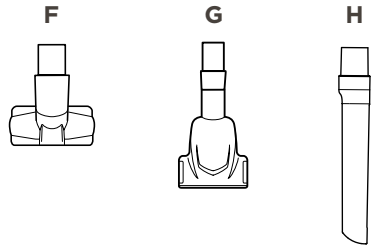

1. Insert wand into floor nozzle.
2. Insert handle into wand.
3. Place pod onto wand. Slide down to connect.
4. Connect hose to back of pod, pressing until it clicks into place.

ASSEMBLY

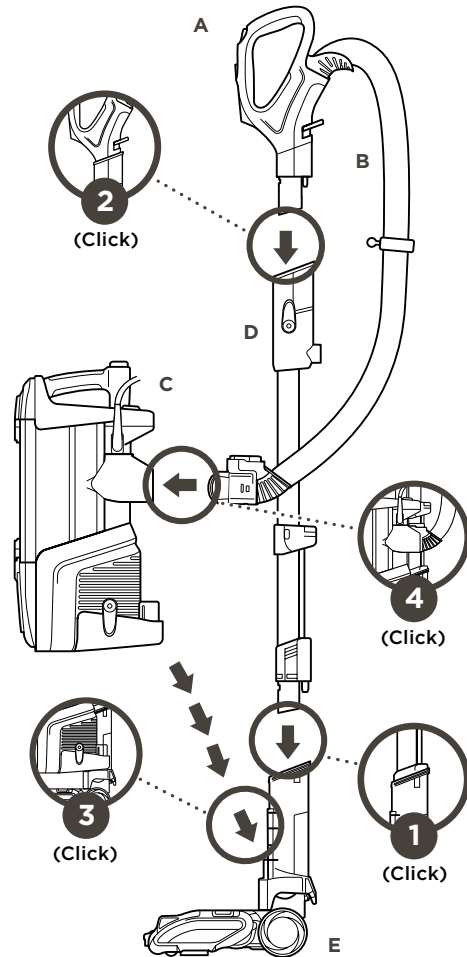

VERSATILE FLOOR-TO-CEILING CLEANING

UPRIGHT MODE

Place your foot gently on the floor nozzle and tilt the handle back. Choose floor type and press power button.

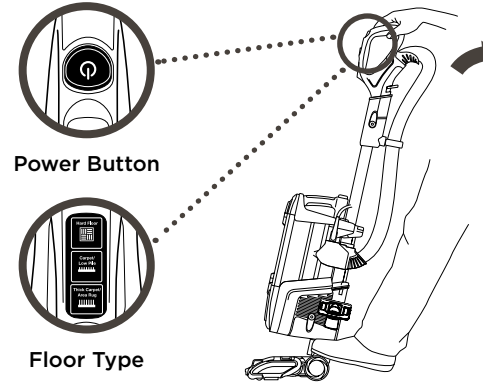

Power Button



Floor Type

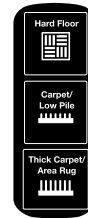

Hard Floor: Gentle on bare floors and delicate area rugs.

Carpet/Low Pile: Optimized brushroll speed and suction for carpets.

Thick Carpet/Area Rug: Optimized brushroll speed and suction for thick carpets.

POWERED LIFT-AWAY® MODE

Press Lift-Away Release button to lift pod off wand to clean hard-to-reach places.

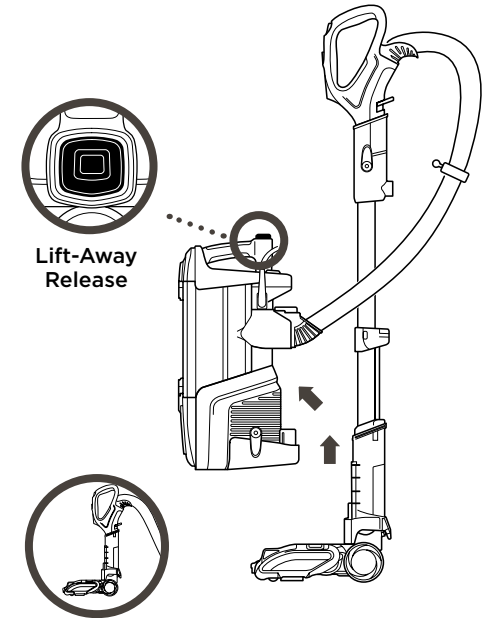

Lift-Away Release

HAVING TROUBLE?

ISSUE

Vacuum is not picking up debris. No suction or light suction.

Solution

Empty dust cup, clean filters, check all openings for blockages.

ISSUE

Vacuum lifts area rugs.

Solution

Turn off the unit to disengage the brushrolls and restart with the Power button.

ISSUE

Brushroll and/or Soft Roller does not spin. The Brushroll Indicator Light on the floor nozzle turns red.

Solution

Turn off the unit and move away from any obstruction, then turn on power and tilt handle back. If the light remains red, turn off and unplug the vacuum. Disconnect the nozzle and remove any blockages. Make sure the brushroll lid is firmly

locked into position on both sides. Plug in the vacuum, turn on power, and tilt handle back. If the Brushroll Indicator Light isn't green and headlights are flashing, check again that both sides of the lid are locked into place. If the light is still red, please visit sharkclean.com/support for additional information.

DUOCLEAN® TECHNOLOGY

ON FLOORS

Direct engagement with the Soft Roller removes large particles, small particles, and stuck-on dust.

Hard Floor

Gentle on bare floors and delicate area rugs.

The brushroll and the Soft Roller both spin together slowly to help with debris pickup.

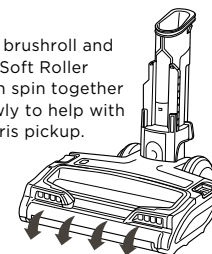

ON CARPETS*

The Soft Roller pulls in large particles, while the deep-cleaning bristle brush removes embedded fine dirt.

Carpet/Low Pile

Optimized brushroll speed and suction for carpets.

Both brushrolls spin faster to help pick up debris below the surface.

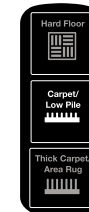
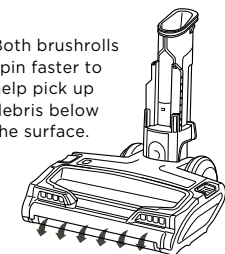

Thick Carpet/Area Rug

Suction for thick carpets and area rugs.

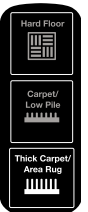

*For deep cleaning per ASTM F 608 (embedded dirt in carpet) please use in Carpet/Low Pile mode. ©2019 Sharkninja Operating LLC