

Shark

Air Purifier

HP100 Series



OWNER'S GUIDE

IMPORTANT SAFETY INSTRUCTIONS

HOUSEHOLD USE ONLY

⚠ WARNING

TO REDUCE THE RISK OF FIRE, ELECTRIC SHOCK, OR INJURY:

GENERAL WARNINGS

1. This appliance has a polarized plug (one blade is wider than the other). To reduce the risk of electric shock, this plug is intended to fit in a polarized outlet only one way. If the plug does not fit fully in the outlet, reverse the plug. If it still does not fit, contact a qualified electrician. Do not attempt to defeat this safety feature. Unplug or disconnect the appliance from the power supply before servicing.
2. **DO NOT** operate any unit with a damaged cord or plug. Discard the unit or return to an authorized service facility for examination and/or repair.
3. **DO NOT** run cord under carpeting. **DO NOT** cover cord with throw rugs, runners, or similar coverings. **DO NOT** route cord under furniture or appliances. Keep cord away from high traffic areas where it will not be tripped over.
4. If the power cord is damaged, it must be replaced by the manufacturer, its service agent, or similarly qualified persons in order to avoid a hazard.
5. This appliance is not intended for use by anyone (including children) with reduced physical, sensory or mental capabilities, or lack of experience and knowledge, unless they have been given supervision or instruction concerning use of the appliance by a person responsible for their safety.
6. Children should be supervised to ensure that they **DO NOT** play with the appliance.
7. Cleaning and user maintenance shall not be made by children without supervision.
8. Prior to cleaning or other maintenance, the appliance must be unplugged from the electrical outlet.
9. **DO NOT** handle plug or appliance with wet hands.
10. **DO NOT** use without filter in place.
11. Only use Shark® branded filters and accessories.
12. **DO NOT** damage the power cord:
 - a) **DO NOT** pull or carry appliance by the cord or use the cord as a handle.
 - b) **DO NOT** unplug by pulling on cord. Grasp the plug, not the cord.
 - c) **DO NOT** stand the appliance on the power cord, close a door on the cord, pull the cord around sharp corners, or leave the cord near heated surfaces.
13. **DO NOT** use with any opening blocked; keep free of dust, lint, hair, and anything that may reduce airflow.
14. **DO NOT** use if airflow is restricted. If the air paths become blocked, turn the appliance off and unplug from electrical outlet. Remove all obstructions before you plug in and turn on the unit again.
15. **DO NOT** use if appliance is not working as it should, or has been dropped, damaged, left outdoors, or dropped into water.
16. **DO NOT** place appliance on unstable surfaces such as chairs or tables.
17. **DO NOT** use in the following areas:
 - a) Wet or damp surfaces
 - b) Outdoor areas
 - c) Spaces that are enclosed and may contain explosive or toxic fumes or vapors (lighter fluid, gasoline, kerosene, paint, paint thinners, mothproofing substances, or flammable dust)
18. Turn off all controls before plugging in or unplugging the appliance.
19. Unplug from electrical outlet when not in use and before any maintenance or cleaning.
20. Hand-wash with water only. Washing with cleaning chemicals could damage the unit.
21. Make sure filter is in place after routine maintenance.
22. Not suitable for use with solid-state speed controls.

REMOTE BATTERY

23. Dispose of batteries properly. Keep batteries away from children at all times. Even used batteries can cause injury.

⚠ WARNING: Chemical Burn Hazard. Keep batteries away from children.

This product contains a lithium button/coin cell battery. If a new or used lithium button/coin cell battery is swallowed or enters the body, it can cause severe internal burns and can lead to death in as little as 2 hours. When not changing batteries, keep the battery compartment completely closed. If the battery compartment does not close securely, stop using the product, remove the batteries, and keep them away from children. If you think batteries might have been swallowed or placed inside any part of the body, seek immediate medical attention.

SAVE THESE INSTRUCTIONS

Parts:

1. Air Output Vents
2. Control Panel
3. Front Display
4. Air Purifier Base
5. Air Intake Vents
6. Filter
7. Filter Door
8. *Odor Neutralizer Technology Dial



TIPS FOR SETTING UP YOUR AIR PURIFIER

- Make sure the front panel faces away from the closest wall.
- Do not move the unit while it is running. Turn off the power and unplug the air purifier before moving it.
- Make sure the air intake vents are not blocked.
- Do not place anything on the air purifier.
- Do not place the air purifier near heaters or radiators.
- Keep the air purifier out of direct sunlight and away from water or other liquid.
- Keep all nearby doors and windows closed when operating the air purifier.
- Avoid using in very humid environments.

Note: Odor Neutralizer Technology is not included on all Shark HP100 series products.

SETTING UP YOUR AIR PURIFIER



1. **DO NOT** plug in your air purifier immediately. Carefully turn the air purifier upside down and place it on a level surface. Rotate the filter door counterclockwise to unlock it, take out the filter, and remove the filter from the plastic packaging.

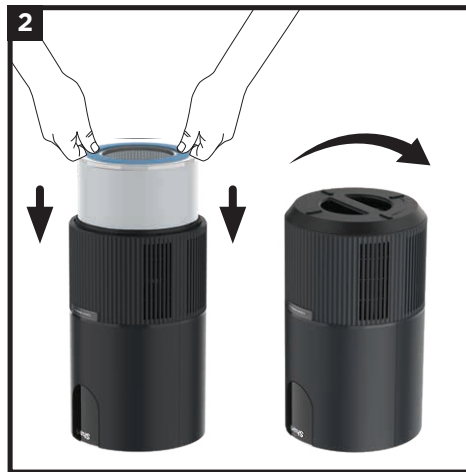

2. Reinstall the filter and twist the filter door clockwise until it clicks into place.

Odor Neutralizer Technology
Some purifiers come with an Odor Neutralizer Technology cartridge. If your unit has Odor Neutralizer Technology, locate the odor cartridge and follow the installation instructions on the packaging.



3. Set up the air purifier on a level surface, at least 3 inches (8 cm) from walls and objects. Plug the air purifier into an electrical outlet and press the power button on the top of the panel.

UNDERSTANDING YOUR AIR QUALITY



When the unit is powered on, it will begin to analyze the air quality, indicated by the rotating lights. After a few seconds, the unit will display the current air quality.



CONTROL PANEL

There is a control panel on the top of the air purifier and a display screen on the front of the air purifier.

TOP CONTROL PANEL

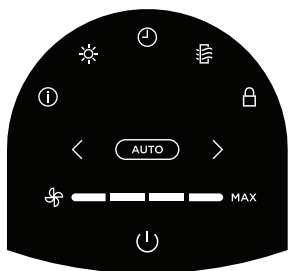









FRONT DISPLAY SCREEN



Displays the current air quality status based on the Air Info mode selected on the top control panel.



TOP CONTROL PANEL BUTTONS









-  **On/Off:** Press to turn the power on or off.
-  **Auto Mode:** Press to turn on Auto Mode. In this setting the fan speed automatically adjusts based on real time air quality readings. As the air quality improves, the fan speed will decrease. If air quality worsens, the fan speed will increase. **Leave your unit in Auto Mode for optimal filter life and performance.**
-  **Fan Speed:** Adjusts the speed of the fan. Select one of 4 settings: 1 Low, 2 Medium, 3 High, 4 Maximum. Note: If fan speed is manually changed, Auto Mode will be deactivated. For tips and more information, see the Optimizing Fan Speed section.
-  **Air Info:** Press to switch between air quality display options. See the Air Info Settings section for more information.
-  **Brightness:** Adjusts the brightness of both the front display screen and the top control panel. Switch between 3 options: full brightness, partially dim, fully dim.
-  **Shut-Off Timer:** Set the number of hours for the air purifier to run before it automatically shuts off. Timer can be set from 1 to 12 hours.
-  **Filter Life:** Press to show the remaining filter life. Once the filter has 0% remaining, the FILTER LIFE button will flash to indicate the filter needs to be changed. See the Installing and Removing the Filter section for more information.
-  **Child Lock:** Press and hold for two seconds to lock the top control panel buttons. To unlock, press and hold for two seconds again.

Tips and Tricks:

-  **Optimize Performance in Eco Mode:** After 100% clean air status is achieved for 10 minutes in Auto Mode, your air purifier will enter Eco Mode. Your unit's filter life will be optimized.
-  **Control Your Air Purifier's Beeping:** Press and hold the Air Info and Child Lock buttons at the same time for two seconds to turn this setting on or off.

AIR INFO SETTINGS

The built-in sensor detects your air quality to give you real-time information. Use the **AIR INFO** button  to switch between air quality display options.

INFO	FRONT DISPLAY SCREEN	REAL-TIME READING
% CLEAN AIR		Displays the air quality rating: <ul style="list-style-type: none"> • Poor: 0%–69% • Fair: 70%–84% • Good: 85%–100% % CLEAN AIR uses particulate matter (PM) Air Quality Standards as determined by the EPA to calculate the air quality rating.
TIME TO CLEAN AIR MIN		Shows the estimated time remaining until your air is clean.
PARTICLE SIZES		The PM (particulate matter) value is the amount of particulate in your air, measured in micrograms (µg) per cubic meter. Your air purifier measures three particle sizes, PM1, PM2.5, and PM10.
PM1 		Displays the amount of PM1-sized particles in your air, including ultra-fine allergens.
PM2.5 		Displays the amount of PM2.5-sized particles in your air, including smoke.
PM10 		Displays the amount of PM10-sized particles in your air, including dust and pollen.

UNDERSTANDING YOUR AIR QUALITY

The rings on the front and top displays will change color as your air quality changes, allowing you to easily monitor your air quality even when you are far from the unit.

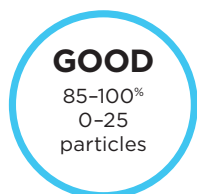

A blue ring means your air quality is good, with a low level of particle concentration.

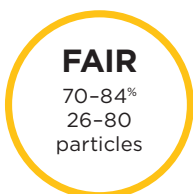

An amber ring means your air quality is fair, with a moderate level of particle concentration. For better results, increase fan speed or select Auto Mode.

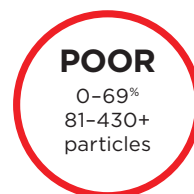

A red ring means your air quality is poor, with a high level of particle concentration. For better results, increase fan speed or select Auto Mode.

Note: The air quality sensor uses a cumulative particle count across all particle sizes to determine percentage of clean air.

OPTIMIZING FAN SPEED

Your air purifier is equipped with 4 fan speed settings. Adjust fan speed to optimize your cleaning performance.

DISPLAY	SPEED	BEST FOR
	1	Quiet Operation
	2	Reducing Odors
	3	Reducing Allergens
	4	Maximum Cleaning

TROUBLESHOOTING AND FREQUENTLY ASKED QUESTIONS

Product	What are the recommended settings?	We recommend using this air purifier in Auto Mode. Auto Mode leverages your air purifier's particle sensor, and this adjusts the fan speed automatically. Higher fan speeds work best for allergy sufferers and dirty environments.
	What is Eco Mode?	After 100% clean air is achieved for 10 minutes in Auto Mode, your air purifier will enter Eco Mode. The fan will turn off until particles are detected. This will optimize your filter's life.
	Can I mute the air purifier so it doesn't beep?	To control your unit's beeping, press and hold the Air Info and Child Lock buttons at the same time for two seconds.
	Why are my control panel buttons not working?	Your air purifier may have the child lock setting activated. Press and hold the Child Lock button for two seconds to turn this setting on or off.
Air Quality	How frequently should I replace my odor cartridges?	Odor cartridges should be replaced every 3 months or as needed for optimal Odor Neutralizer Technology performance. <i>*Odor Neutralizer Technology is not included on all Shark HP100 series products.</i>
	Why is my air quality always at 100%?	If your air purifier displays a blue ring, your air quality is good. However, air quality will fluctuate as you introduce pollutants into your home. Activities like smoking, cooking, dusting, or spraying cleaning products (among other things) can add more pollutants to your air. Our Clean Sense IQ™ technology tracks this fluctuation in real time and adjusts as it detects particles. To determine if the sensor is working correctly, spray perfume or aerosol cleaning product near the sensor above the filter door. Please visit: sharkclean.com/support for more information.
Filter	Why is my air quality never at 100%?	If your air quality never reaches 100%, make sure that the filter is properly installed and that its original plastic packaging has been removed. Activities like smoking, burning candles, running a humidifier, opening windows, and cooking (among other things) can add more pollutants to your air. Make sure to survey your environment and remove anything that could be causing low air quality.
	Can I wash the filter?	No, the filter is not washable. Keep filter away from water and dispose of it when it is dirty.
	How often should I replace the filter?	We recommend replacing the filter every 6-12 months.
	How do I optimize filter life?	To maximize the life of the filter, reorient it every three months: remove the filter, turn it upside down, then reinsert it, making sure that the side that was previously on top is now on the bottom. This will help equalize the distribution of captured particles throughout the filter, helping to extend its useful life.
	Where can I buy replacement filters?	You can buy replacement filters from select retailers or at: sharkaccessories.com

Customer Service

For further assistance, call 1-855-523-4061.

INSTALLING AND REMOVING THE FILTER

NOTE: Always remove all protective packaging from the filter before installing.

When the filter timer has 0% remaining, the FILTER LIFE button on the top control panel will blink, indicating that it's time to install a new filter.

1. Turn off and unplug the unit before removing or installing filters.
2. Carefully turn the air purifier upside down. Remove the bottom filter by rotating it to the unlocked position.
3. To remove the old filter, pull it out by the removal tabs. Discard old filter in trash.
4. Remove all packaging and wrapping from the new filter.
5. Insert the new filter, then replace the filter door. Rotate the filter door until it clicks into place.
6. Carefully return the air purifier to the upright position. Plug the unit back in and turn on power. Calibration will begin.
7. After installing a new filter, press and hold the Filter Life button on the top control panel for 3 seconds to reset the filter life percentage. The unit will beep when the filter life is reset to 100%.



Disposing of used filters

Filters can't be cleaned or recycled. After removing a used filter, wrap it in an airtight plastic bag for disposal. As an extra precaution, wear gloves when handling a dirty filter.

MAINTAINING YOUR AIR PURIFIER

NOTE: Always unplug the unit before doing any cleaning or maintenance.

Exterior Cleaning:

For best results, clean the exterior every two months or as needed. Use a microfiber cloth to remove dust. To clean, wipe down the exterior with a microfiber cloth dampened with warm, soapy water. Avoid excess water and abrasive chemical cleaners to prevent damage.



Interior Cleaning:

For best results, clean the interior of the air purifier every two months or as needed. Remove the filter door, take out the filter, and use a vacuum cleaner or a microfiber cloth to remove dust and debris from the interior. **DO NOT** use abrasive chemical cleaners on the inside of the air purifier.



To maximize the life of the filter, reorient it every three months: remove the filter, turn it upside down, then reinsert it, making sure that the side that was previously on top is now on the bottom. This will help equalize the distribution of captured particles throughout the filter, helping to extend its useful life.

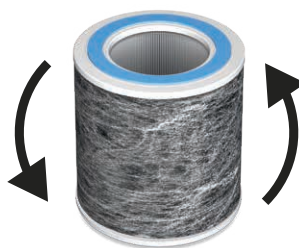

ODOR NEUTRALIZER TECHNOLOGY

NOTE: Odor Neutralizer Technology is not included on all Shark HP100 series products.

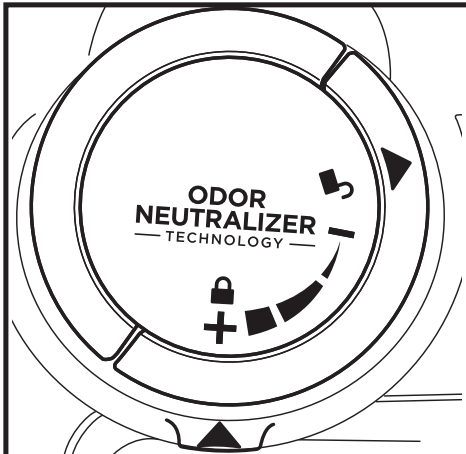

1. OPEN THE PACKAGED ODOR CARTRIDGE ASSEMBLY

Remove the odor cartridge assembly from the cardboard box and aluminum bag.

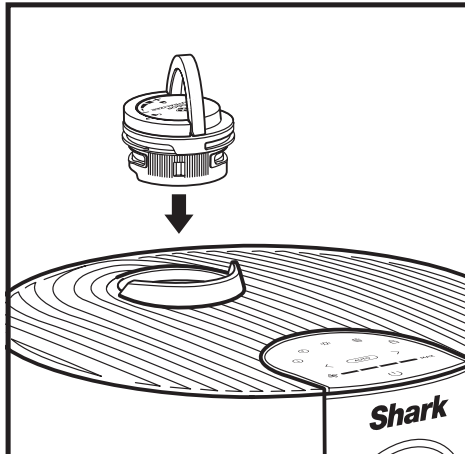

2. INSERT ODOR CARTRIDGE ASSEMBLY INTO AIR PURIFIER

Flip up the handle on the odor dial, align the arrows, then insert the assembly into the air purifier.

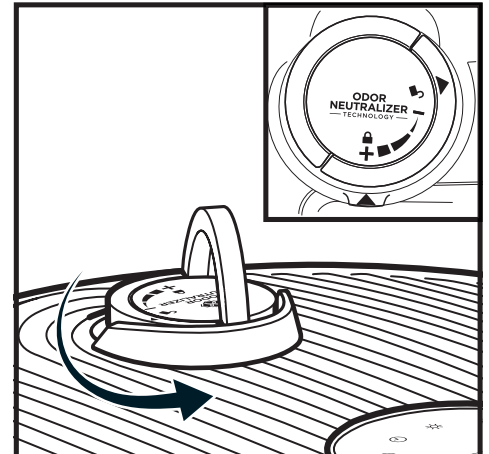

3. ROTATE UNTIL CLICK

To lock and engage the odor cartridge assembly, rotate it counterclockwise until it clicks at least once. Continue to rotate the dial toward the high position to increase the intensity.

SETTINGS

Settings: The Odor Neutralizer Technology dial has 4 intensity settings: Low, Medium, High, and Off.

ODOR DIAL POSITION	CLICKS	SETTING	RECOMMENDED FOR
	1	OFF	<ul style="list-style-type: none"> When you are not actively looking to reduce odors. This will extend the life of the odor cartridge.
	2	LOW	<ul style="list-style-type: none"> Mild odor events such as trash smells. Small spaces like a bathroom or entryway.
	3	MEDIUM	<ul style="list-style-type: none"> Strong odor events such as cooking or pet smells. Mid-sized spaces like a bedroom or kitchen.
	4	HIGH	<ul style="list-style-type: none"> Optimal odor-reducing performance. Extreme odor events such as smoke or lingering burnt smells. Large spaces like a living room or multiple rooms.

Note: Adjusting the fan speed is another way to control Odor Neutralizer Technology intensity. See the Optimizing Fan Speed section for more information.

LOW
Rotate the dial to the Low position to decrease intensity to the lowest level when in use.

HIGH
Rotate the dial to the High position to increase intensity to the highest level when in use.

TIPS

Odor Cartridge Removal

- Remove the odor cartridge from the dial if you don't want to use Odor Neutralizer Technology.
- To remove the cartridge, flip up the handle and rotate the odor dial clockwise until the two arrows are aligned. Pull the handle to remove the dial and access the cartridge.

Maintenance Required

- Replace the cartridge as recommended under Odor Cartridge Replacement.
- Visit qr.sharkclean.com/odortech to learn more and purchase replacements.

Fragrance Strength Over Time

- The intensity of the Odor Neutralizer Technology's fragrance may diminish over time. It may also have no noticeable fragrance at all. This is natural and does not indicate that the technology is not working. Follow replacement instructions to ensure continued performance.

ODOR NEUTRALIZER TECHNOLOGY REPLACEMENT

NOTE: Odor Neutralizer Technology is not included on all Shark HP100 series products.

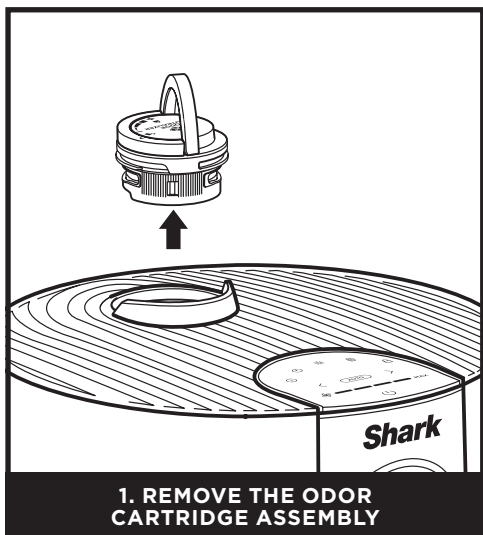

Flip up the handle and rotate the dial counterclockwise until the two arrows are aligned. Pull the handle to remove the dial from the air purifier.



Rotate the cartridge counterclockwise in the dial housing and pull out the cartridge to remove it.

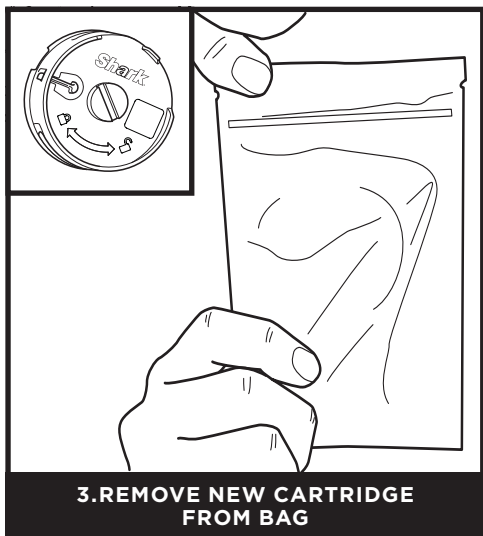

Remove the new odor cartridge from the sealed packaging. To maintain the life of the cartridge, keep it in the sealed packaging until you are ready to install it.

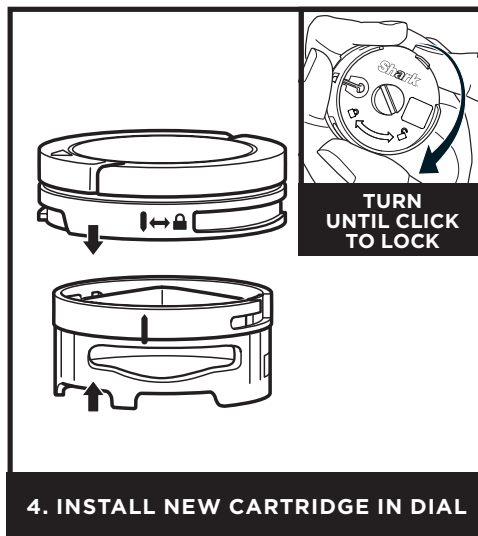

Align the yellow arrow on the side of the cartridge with the yellow arrow on the side of the dial cover, then insert the cartridge into the dial. Rotate the cartridge clockwise to lock it in place.

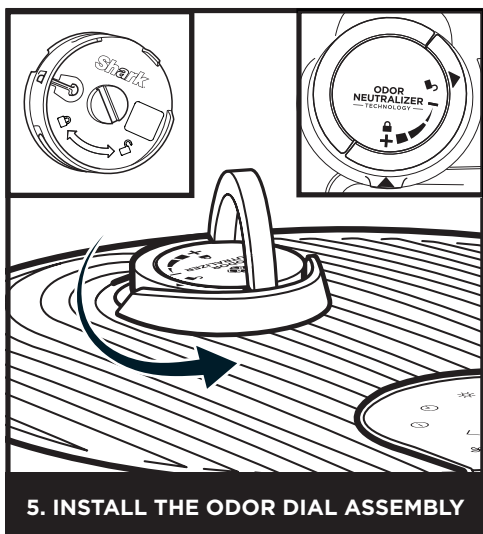

Align the arrow on the dial cover with the arrow on the air purifier, then reinsert the dial into the air purifier. Rotate the dial counterclockwise until it clicks into an intensity setting to engage. Rotate further to change the intensity setting.



Dispose of the old cartridge by dropping it into the trash.

Note: Odor cartridges should be replaced every 3 months or as needed for optimal Odor Neutralizer Technology performance.

AVAILABLE ACCESSORIES

ORDER ADDITIONAL ACCESSORIES AND REPLACEMENT FILTERS

Additional accessories and replacement filters are available on sharkaccessories.com



Odor Neutralizer Technology Cartridges (2)

Two replacement cartridges that guard against bad odors for a fresher-smelling home. We recommend replacing cartridges every 3 months or as needed in your air purifier. Odor Neutralizer Technology intensity dial sold separately.



Remote Control

Use the remote control to operate your air purifier from a distance.

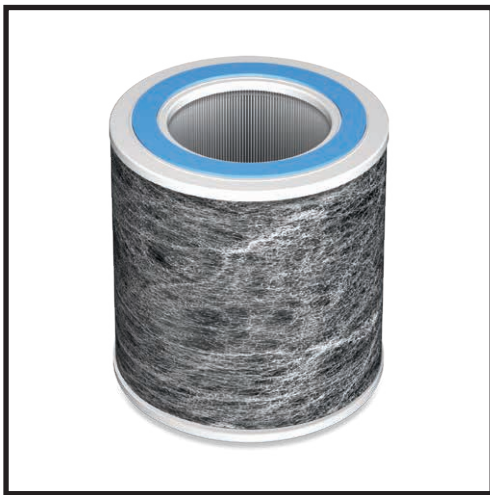

SHARK NANOSEAL™ FILTER WITH TRUE HEPA

Captures 99.98% of large, small, & micro-sized particles from the air and is equipped with carbon for heightened protection against household odors and VOCs.

REMOTE CONTROL BUTTONS

- 1. On/Off:** Turns the air purifier on/off.
- 2. Air Info:** Switch between air quality display options.
- 3. Auto:** Enables Auto Mode.
- 4. Brightness:** Adjusts brightness.
- 5. Fan Speed:** Adjusts fan speed.
- 6. Shut-Off Timer:** Sets shut-off timer.



TWO (2) YEAR LIMITED WARRANTY

The Two (2) Year Limited Warranty applies to purchases made from authorized retailers of **SharkNinja Operating LLC**. Warranty coverage applies to the original owner and to the original product only and is not transferable.

SharkNinja warrants that the unit shall be free from defects in material and workmanship for a period of two (2) years from the date of purchase when it is used under normal household conditions and maintained according to the requirements outlined in the Owner's Guide, subject to the following conditions and exclusions:

What is covered by this warranty?

1. The original unit and/or non-wearable parts deemed defective, in SharkNinja's sole discretion, will be repaired or replaced up to two (2) years from the original purchase date.
2. In the event a replacement unit is issued, the warranty coverage ends six (6) months following the receipt date of the replacement unit or the remainder of the existing warranty, whichever is later. SharkNinja reserves the right to replace the unit with one of equal or greater value.

What is not covered by this warranty?

1. Normal wear and tear of wearable parts (such as filters and batteries, etc.), which require regular maintenance and/or replacement to ensure the proper functioning of your unit, are not covered by this warranty. Replacement parts are available for purchase at sharkaccessories.com.
2. Any unit that has been tampered with or used for commercial purposes.
3. Damage caused by misuse, abuse, negligent handling, failure to perform required maintenance (e.g., not replacing the filters), or damage due to mishandling in transit.
4. Consequential and incidental damages.

5. Defects caused by repair persons not authorized by SharkNinja. These defects include damages caused in the process of shipping, altering, or repairing the SharkNinja product (or any of its parts) when the repair is performed by a repair person not authorized by SharkNinja.
6. Products purchased, used, or operated outside North America.

How to get service

If your appliance fails to operate properly while in use under normal household conditions within the warranty period, visit sharkclean.com/support for product care and maintenance self-help. Our Customer Service Specialists are also available at **1-855-523-4061** to assist with product support and warranty service options, including the possibility of upgrading to our VIP warranty service options for select product categories. So we may better assist you, please register your product online at registeryourshark.com and have the product on hand when you call.

SharkNinja will cover the cost for the customer to send in the unit to us for repair or replacement. A fee of \$25.95 (subject to change) will be charged when SharkNinja ships the repaired or replacement unit.

How to initiate a warranty claim

You must call **1-855-523-4061** to initiate a warranty claim. You will need the receipt as proof of purchase. We also ask that you register your product online at registeryourshark.com and have the product on hand when you call, so we may better assist you. A Customer Service Specialist will provide you with return and packing instruction information.

How state law applies

This warranty gives you specific legal rights, and you also may have other rights that vary from state to state. Some states do not permit the exclusion or limitation of incidental or consequential damages, so the above may not apply to you.

IMPORTANT INFORMATION

REGISTER YOUR PURCHASE



registeryourshark.com



Scan QR code using mobile device



RECORD THIS INFORMATION

Model Number: _____

Serial Number: _____

Date of Purchase: _____
(Keep receipt)

Store of Purchase: _____

TECHNICAL SPECIFICATIONS

Voltage: 120V~ 60Hz

Watts: 24W

Benefits of registering your product and creating an account:

- Get easier, faster product support and access to warranty information
- Access troubleshooting and product care instructions
- Be among the first to know about exclusive product promotions

TIP: You can find the model and serial numbers on the QR code label on the bottom of the unit.

PLEASE READ CAREFULLY AND KEEP FOR FUTURE REFERENCE.

This Owner's Guide is designed to help you get a complete understanding of your new Shark® Air Purifier.

SharkNinja Operating LLC
US: Needham, MA 02494
CAN: Ville St-Laurent, QC H4S 1A7
1-800-798-7398
sharkclean.com

Illustrations may differ from actual product. We are constantly striving to improve our products; therefore the specifications contained herein are subject to change without notice.

This product may be covered by one or more U.S. patents. See sharkninja.com/patents for more information.

BATTERY REMOVAL AND DISPOSAL

This product's remote control uses a lithium button battery. When the battery no longer has a charge, it should be removed from the remote and recycled. **DO NOT** incinerate or compost the battery.

When your lithium battery needs to be replaced, dispose of it or recycle it in accordance with local ordinances or regulations. In some areas, it is illegal to place spent lithium batteries in the trash or in a municipal solid waste stream. Return spent battery to an authorized recycling center or to retailer for recycling. Contact your local recycling center for information on where to drop off the spent battery.



FCC WARNINGS

Note: This unit has been tested and found to comply with FCC limits for Class B digital devices. These limits are designed to provide reasonable protection against harmful interference in a residential installation. This unit generates, uses, and can radiate radio frequency energy, and if not installed and used in accordance with the instructions, may cause harmful interference to radio communications.

This device complies with part 15 of the FCC Rules. Operation is subject to the following two conditions: (1) this device may not cause harmful interference, and (2) this device must accept any interference received, including interference that may cause undesired operation.

To correct any interference:

- Reorient or relocate the receiving antenna.
- Increase the distance between the unit and the receiver.
- Connect the unit to a different outlet than the receiver.
- Consult the dealer or an experienced technician for help.

Caution: Any changes or modifications to this unit not expressly approved by the party responsible for compliance could void the user's authority to operate it.