

Please be sure to read the enclosed Shark® Owner's Guide prior to using your unit.

Shark® Rocket™ DELUXE PRO Ultra-Light Upright

QUICK START GUIDE

WHAT'S INSIDE

- A** Handheld Vacuum
- B** Motorized Floor Nozzle
- C** Wand
- D** On-Board Storage Clip
- E** 30 cm (12") Crevice Tool
- F** Dusting Brush
- G** Upholstery Tool
- H** Dust-Away™ Hard Floor Attachment with Pad
- I** Wall Mount

ASSEMBLY

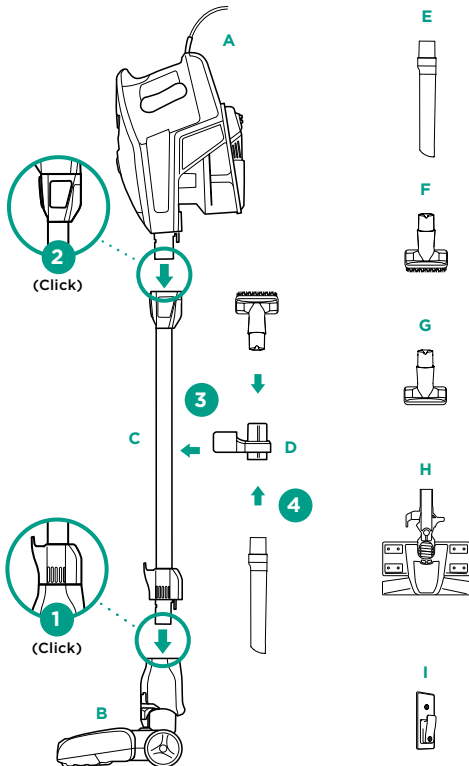

STORAGE

Option 1: Onboard Hook

For compact, convenient storage, hang the handheld vacuum on the hook on the bottom of the wand, and wrap the power cord around the cord hooks. The unit stores easily in a closet or along a wall.

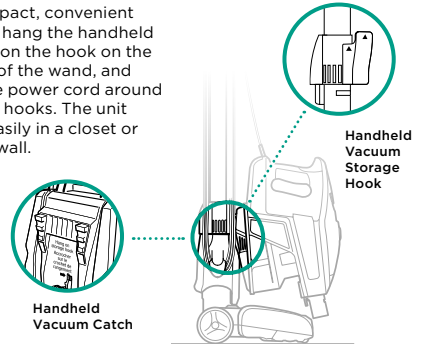

Option 2: Wall Mount

Please see included instruction sheet for wall mount installation information.

MAINTENANCE

Empty the dust cup every time debris reaches the MAX fill line.

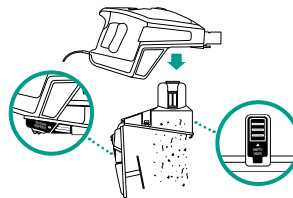

Brushroll Maintenance

A portion of the base is removable to allow for better access to the brushroll and exposure to the airway. Remove any string, carpet fibers, or hair that may be wrapped around the brushroll. Loosen debris by cutting across the groove on the brushroll with a pair of scissors.

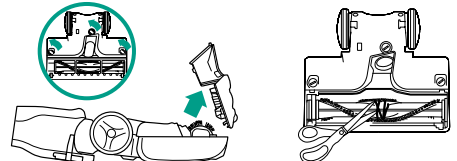

VERSATILE FLOOR-TO-CEILING CLEANING

FLOOR CLEANING

- 1 Plug In Vacuum**
Then place your foot gently on the floor nozzle and tilt the handle back.

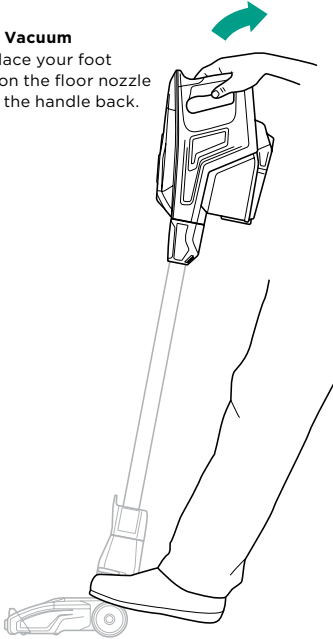

- 2 Choose Setting**
The Rocket™ Deluxe Pro has a 2-speed power slider switch on the handle. Slide the power switch to the appropriate floor setting and start cleaning.

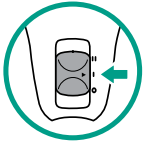

Setting I
Gentle on bare floors and delicate area rugs.
The brushroll spins slowly to clean bare floors and delicate area rugs.

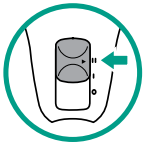

Setting II
Deep cleans carpets by removing embedded dirt.
The brushroll spins faster to pick up debris below the surface of your carpets.

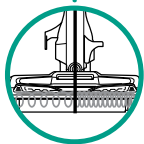

NOTE: For deep cleaning per ASTM F 608 (embedded dirt in carpet) please use Setting II, high pile carpet mode.

ABOVE-FLOOR CLEANING

- 1** Stand the vacuum upright. Step on the foot pedal and pull the wand up to disconnect it from the motorized floor nozzle.

OR

Press the Wand Release button on the top of the wand to disconnect it from the handheld vacuum.

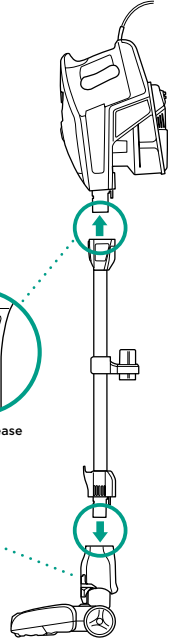

Wand Release

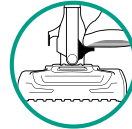

Floor Nozzle Release

- 2** Attach desired cleaning accessory.

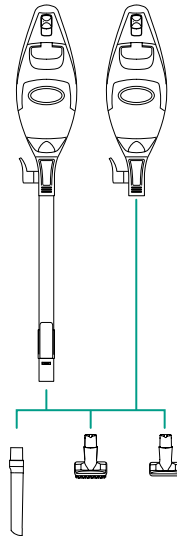

NOTE: Use Setting I for all above-floor accessories.

For questions or to register your product, contact us at 1-800-798-7398 or visit us online at sharkclean.com



@sharkcleaning