

Please be sure to read the enclosed Shark® Owner's Guide prior to using your unit.

Shark ROTATOR™ LIFT-AWAY™ PROFESSIONAL

QUICK START GUIDE

WHAT'S INSIDE

- A Handle
- B Hose
- C Wand
- D Vacuum Pod
- E Motorized Floor Nozzle
- F 12" Crevice Tool
- G Dusting Brush
- H Wide Upholstery Tool

ASSEMBLY

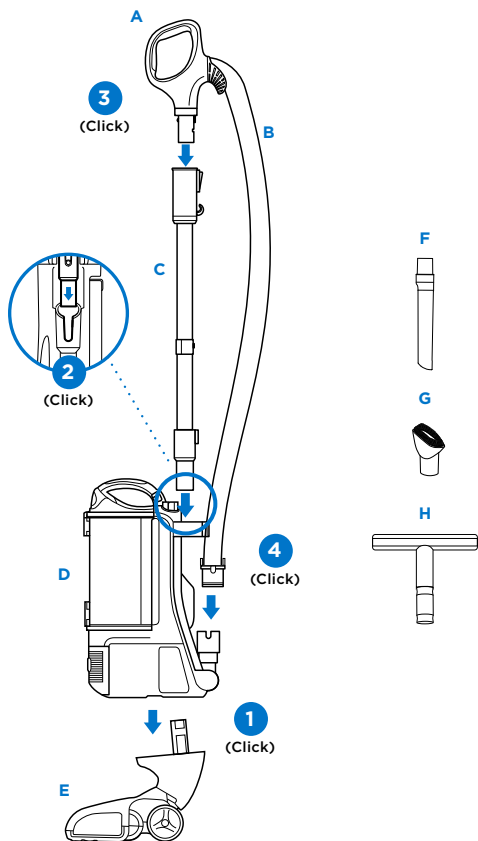

ATTACH ONBOARD ACCESSORIES

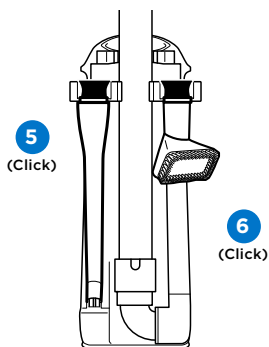

MAINTENANCE

Empty the dust cup after each use.

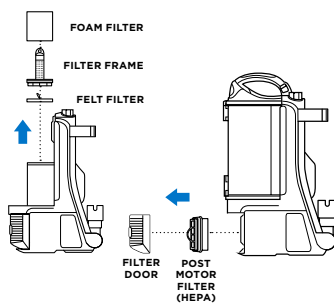
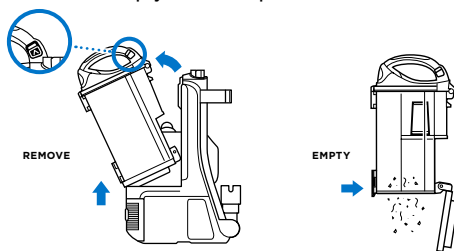

TIP: Wash foam and felt filters every 3 months, and HEPA filter once a year.

Rinse with water only and allow to air-dry completely before reinstalling. Tap loose dirt from filters as needed between washes.

Note: The foam filter may discolor over time. This is normal.

2 WAYS TO CLEAN

UPRIGHT

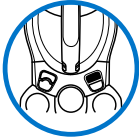

POWER
For cleaning bare floors
or with accessories.

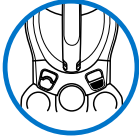

BRUSHROLL
For carpet cleaning
with brushroll

To engage brushroll, place
foot on floor nozzle and
tilt handle back.

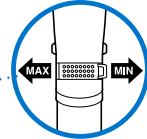
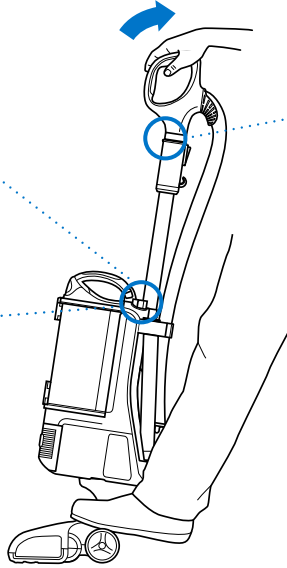

Suction Control
MIN: to reduce suction and
increase maneuverability on
carpets.
MAX: to increase suction on
bare floors.

LIFT-AWAY™

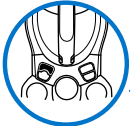

Lift-Away
Release

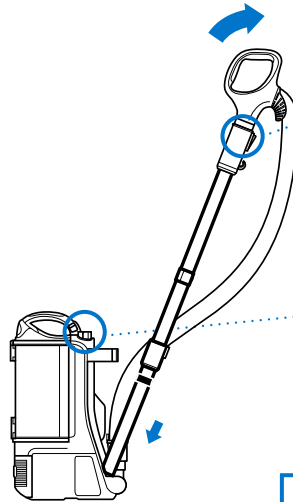
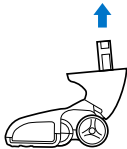
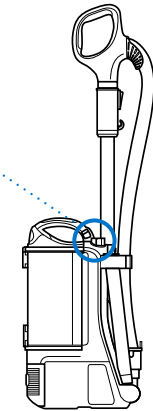

Handle Release

OR

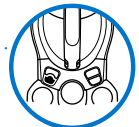

Wand Release

Attach accessories to
handle or wand.

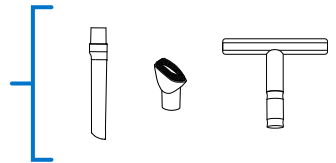

For additional parts and accessories,
visit sharkaccessories.com

For questions or to register your product, visit us online at sharkclean.com

Shark ROTATOR™ LIFT-AWAY™ PROFESSIONAL

GUIDE DE DÉMARRAGE RAPIDE

CONTENU :

- A Poignée
- B Tuyau
- C Tube
- D Réceptacle de l'aspirateur
- E Buse de plancher motorisée
- F Tuyère
- G Brosse à épousseter
- H Outil à meubles large

ASSEMBLAGE

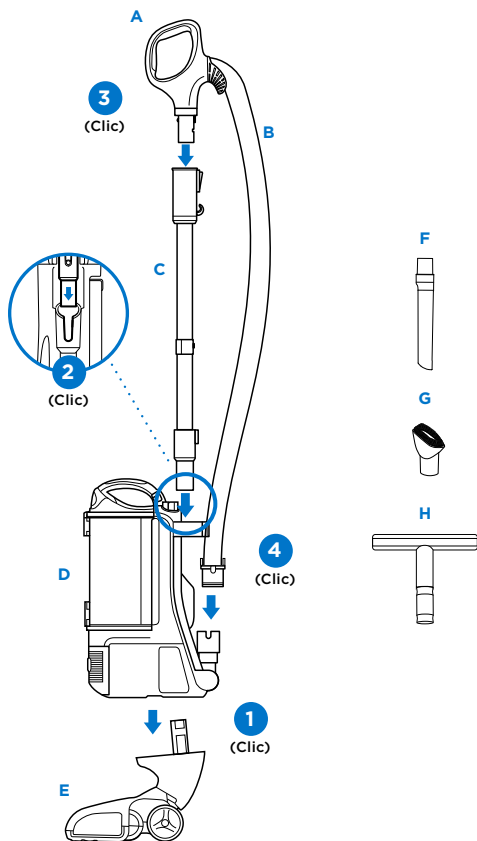

FIXEZ LES ACCESSOIRES INTÉGRÉS

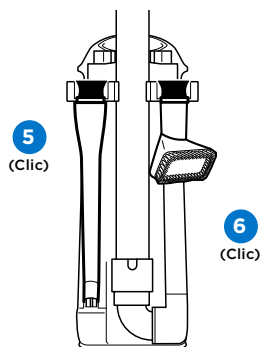

ENTRETIEN

Videz le récipient à poussière après chaque utilisation.

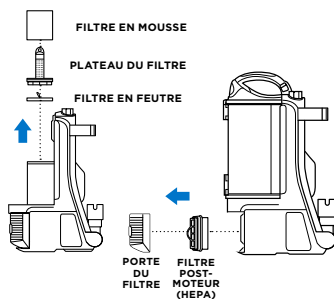
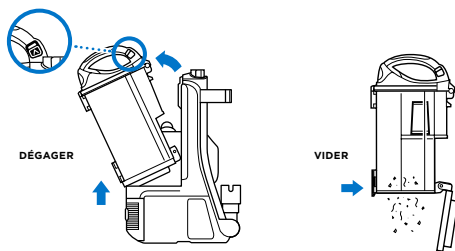

TIP: Nettoyez les filtres pré-moteur tous les 3 mois, et le filtre HEPA chaque année.

Rincez-les avec de l'eau seulement et laissez-les sécher complètement à l'air libre avant de les réinstaller. Tapotez les filtres entre les lavages, au besoin, pour retirer la saleté.

Remarque : Le filtre en mousse peut se décoller avec le temps. C'est normal.

2 FAÇONS DE NETTOYER :

VERTICAL

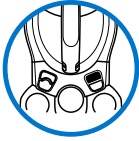

MISE EN MARCHÉ
Pour nettoyer les
planchers ou utiliser avec
des accessoires.

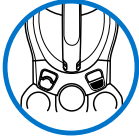

BROSSE ROTATIVE
Pour nettoyer les
tapis avec une brosse
rotative.

Placez le pied sur la buse
de plancher et inclinez la
poignée vers l'arrière pour
activer la brosse rotative.

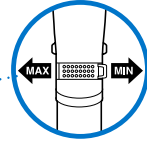
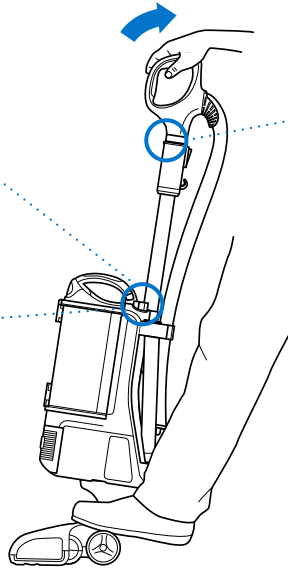

Régulateur d'aspiration
MIN (minimum) : Pour
réduire l'aspiration et
augmenter la maniabilité sur
les tapis.
MAX (maximum) : Pour
augmenter l'aspiration sur
les planchers.

LIFT-AWAY™

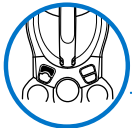

**Dégagement
Lift-Away**

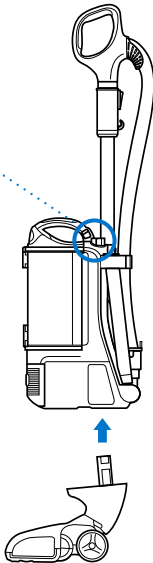

Dégagement de la Poignée

OU

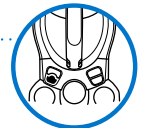

Dégagement du Tube

Attachez les accessoires à
la poignée ou au tube.

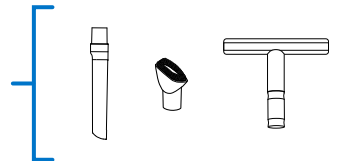

Pour obtenir des pièces et des accessoires
supplémentaires, visitez le site sharkaccessories.com

Pour toute question ou pour l'enregistrement de votre produit, visitez-nous en ligne sur le site sharkclean.com